

VERSION	MODIFY	DATE

PIN	Assignment
1	X-
2	Y-
3	X+
4	Y+

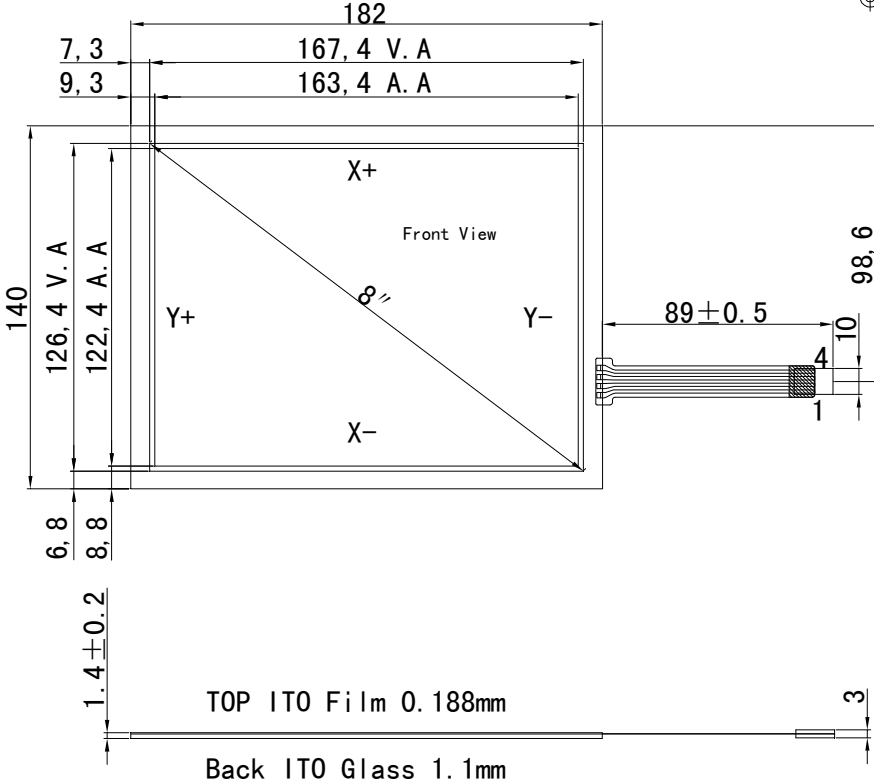
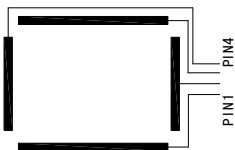

Notes:

1. Type: Film to Glass
2. Operating Voltage: $\leq 10V$
3. Operation Temperature: $-10^{\circ}C \sim 60^{\circ}C$
Storage Temperature: $-20^{\circ}C \sim 70^{\circ}C$
4. Life Time: $> 1,000,000$ times
5. Connect Material: FPC
6. Response Time: $\leq 10ms$
7. Linearity: $\leq 1.5\%$
8. Transmittance: $\geq 80\%$
9. Surface Hardness $\geq 3H$ (pencil)
10. Operation force: 20g~80g
11. Resistance: X : $250\Omega - 450\Omega$
Y : $450\Omega - 800\Omega$

良晨光电有限公司
Lctouch Electronics Co.LTD

MODEL NO.	DRAWN:	DATE:	VERSION:	UNIT:	TOLERANCE:	SCALE:	REV:
TP-08004-01			1.0	MM	± 0.2	1:1	